



## Operating Manual

### BS10

Broadband airborne sound sensor for the SONAPHONE handheld unit

Translation of the German Original

Revision: 2.1 | 2023-04-27

# Content

<b>1</b>	<b>Introduction .....</b>	<b>3</b>
1.1	Notes on this documentation.....	3
1.2	Representations in this documentation .....	3
1.3	Identification of warning instructions .....	4
<b>2</b>	<b>Safety instructions .....</b>	<b>5</b>
2.1	Introduction.....	5
2.2	Basic hazards.....	5
2.3	Personnel and qualifications .....	6
2.4	Safety-conscious working practices .....	6
2.5	Use of the product .....	7
2.6	Modifications and alterations.....	8
<b>3</b>	<b>Description of the sensor.....</b>	<b>9</b>
3.1	Intended use .....	9
3.2	Prohibited use.....	9
3.3	Working principle.....	10
3.4	Sensor construction .....	10
3.5	Sensor identification .....	12
3.6	Accessories.....	13
3.6.1	Small acoustic horn BS10-2 .....	13
3.6.2	Large acoustic horn BS10-3 .....	14
3.6.3	Precise locator BS10-1 .....	14
<b>4</b>	<b>Operation of the sensor .....</b>	<b>15</b>
4.1	Assembling or disassembling the sensor attachments .....	15
4.2	Connecting the sensor .....	16
4.3	Operation via sensor buttons.....	17
<b>5</b>	<b>Cleaning and maintenance .....</b>	<b>18</b>
5.1	Cleaning.....	18
5.2	Maintenance .....	18
<b>6</b>	<b>Technical data .....</b>	<b>19</b>
<b>7</b>	<b>Disposal .....</b>	<b>21</b>
<b>8</b>	<b>Warranty .....</b>	<b>22</b>
<b>9</b>	<b>Manufacturer information.....</b>	<b>23</b>

# 1 Introduction

This section is intended to explain function, structure and representations of this documentation to simplify handling of this documentation.

## 1.1 Notes on this documentation

### Purpose

This documentation constitutes an integral part of the product and contains important advice on safe operation as well as all information on intended and efficient use. Thus, any person using the product must have read and understood this documentation.

### Accessibility

The staff working with this product must have constant access to this documentation to prevent handling errors and guarantee trouble-free operation.

### Up-to-dateness

Every effort has been made to ensure that the information contained in this documentation is complete and correct at the time of release. This documentation describes all units and functions known at the current point of time.

## 1.2 Representations in this documentation

### Illustrations

Illustrations used in this documentation do not always contain all details or special cases. They only represent the relevant information.

### Tips

Tips are marked as follows:

 Tips describe specific information or particular features that might not be evident, even for experienced users. The neglect of a tip poses no direct safety risk. However, it can lead to workflow disruptions.

### General icons

The following general icons are used for visual emphasis:

Icon	Function
	Indicates a link to external content.

---

## 1.3 Identification of warning instructions

Classes of danger, signal words and colors

This documentation contains warnings regarding hazards of different classifications. These classes are characterized by signal words and colors. They include the following:

### **WARNING**

Warns of possible immediate danger, which, if ignored, may lead to lasting damage to health and/or property – including financial losses due to operational impairment.

---

### **ATTENTION**

Warns of dangers, which, if ignored, may lead to damage to property – including damage to property due to operational interruptions.

---

## 2 Safety instructions

This section contains safety information relating to the protection of persons as well as safe and fault-free operation. All user groups of the product must be aware of and follow these safety provisions.

### 2.1 Introduction

Reliable and safe operation of the product depends on the careful handling and execution of operational and setting tasks.

Ignoring these safety instructions and warning information may lead to serious injury with lasting health consequences for personnel as well as damage or destruction of product components.

During handling of the product, please observe all safety instructions and warning information in all parts of this user documentation as well as the related codes of practice. Ensure that all those working with the product are also aware of these instructions.

Generally applicable safety regulations (such as accident prevention and environmental protection regulations, etc.) must also be observed.

### 2.2 Basic hazards

#### Definition

Basic hazards are residual risks that remain even with safety-conscious intended use.

#### State of the art

The product meets the current state of the art and applicable safety rules. All components of the product are tested thoroughly before they leave the factory and are delivered in a condition for safe operation.

#### **▲ WARNING**

##### **Danger of injury!**

Improper use of the product may lead to injuries.

- Do not open the product.
  - Protect the product against extreme heat (excessive sunlight, immediate vicinity of open fire or heating devices) during operation and storage.
  - Avoid strong impacts that could damage the device and/or its components.
-

## 2.3 Personnel and qualifications

### Basic requirements

The product must only be used by operators that have completely read and understood the safety instructions and all documents of the user documentation.

Personnel undergoing training or instructions or persons taking part in general vocational training programs may only operate the device under the continuous supervision of operating or technical personnel.

### Responsibility of the operating company

Regarding the personnel authorized and/or trained by the operating company, the operating company carries the following responsibilities:

- The necessary training and instruction of personnel must be guaranteed.
- All personnel's competences and responsibilities must be clearly stated and documented.
- All user information on the product (operating manual, user documentation etc.) must be kept in the immediate vicinity of the product and must be accessible at all times.

## 2.4 Safety-conscious working practices

### Accident prevention and environmental protection

In addition to the instructions in this operating manual, please mind the generally applicable legal and other regulations on accident prevention and environmental protection.

This may include, for example:

- Handling of hazardous materials
- Wearing the required and mandatory personal protective clothing and safety equipment
- Observing of and complying with all national and regional industrial safety regulations
- Observing of and complying with all internal working, operating and safety regulations

## 2.5 Use of the product

### Measures for personal safety

Improper use of the product may lead to injuries of operating personnel.

- During detection of ultrasonic signals on electrical equipment, make sure to keep the mandatory safety distance from detected electrical defects.
- Always make sure that both hands are free for self-protection, if necessary.
- Always make sure to keep your hands, the product and/or connected equipment within your field of vision.
- Use the torchlight functionality (LED light) of the product and/or additional lighting to illuminate test sites with poor visibility.
- Always use the product without distraction. Do not read messages on the display and/or operate the product while walking.

### Measures for protection of the product and/or equipment

Improper use of the product may lead to product damage. Damaged components may affect or distort the measurement result quality.

- During use, charging and storage, protect the device against extreme, unusual heat (excessive sunlight, storage in heated cars or immediate vicinity of open fire or heating devices). It is critical to stay within the temperature ranges given in the technical specification.
- Do not use the product and its accessories if they display functional errors and/or visible damage.
- Only connect the product to approved equipment received from SONOTEC GmbH or its sales partners.
- The product adheres to the protection class given in the technical specification and is not protected against water. Do not submerge the product in liquids. Protect the product against moisture penetration.
- Handle the product with care and protect it against major shocks.
- When using the product, always make sure that cables cannot get stuck and/or caught in moving parts.
- Do not use the product within strong electromagnetic fields.

## 2.6 Modifications and alterations

No modifications on the product and/or accessories

The product and/or its accessories must not be opened or disassembled. The product does not contain any components to be cleaned, maintained or repaired by operators.

Unauthorized modifications of the product and/or its accessories are prohibited and lead to exclusion of liability by the manufacturer for resulting damage and consequences.

Spare parts and accessories

Spare parts and accessories must comply with the technical requirements specified by SONOTEC GmbH and its suppliers. Whenever original parts are used, compliance is given.



## 3 Description of the sensor

This section describes use, function, structure and accessories of the sensor.

### 3.1 Intended use

The Broadband airborne sound sensor BS10 is used for air-borne sound detection in the ultrasonic range. Used in connection with the SONAPHONE digital ultrasonic testing device and multiple equipment, the sensor has been designed for the following test tasks:

- Detection and evaluation of leaks in compressed air, gas and vacuum systems
- Detection of electrical partial discharge and insulation damage
- Tightness testing of windows, doors, cabins, vehicles or containers (in combination with the SONAPHONE T ultrasonic transmitter)

The sensor's function keys may be used for starting and stopping measurement value recordings and to control the acoustic playback volume. An integrated class 2 target laser and a LED light support locating test sites.

### 3.2 Prohibited use

Any use not approved by SONOTEC GmbH is prohibited and may lead to injury or damage to property.

SONOTEC GmbH accepts no liability for damage caused by prohibited use of the product.

Prohibited are in particular:

- Use of equipment and/or accessories with visible damage
- Use in wet rooms
- Use in potentially explosive environments
- Use in environmental conditions that do not adhere to the stipulated requirements
- Unauthorized modifications of the equipment, the software and/or accessories
- Use of unauthorized spare parts and/or unauthorized accessories

### 3.3 Working principle

The sensor attachments guide the ultrasound to the ultrasonic microphone.

The sensor's ultrasonic microphone converts sound pressure fluctuations in the air to an electrical signal over a wide frequency range. This electrical signal is amplified and digitalized within the sensor. Further data processing and output takes place in the testing device.

The target laser helps with precisely locating damaged areas:

If the sensor points towards the damaged area during the search, the precise location may be detected by means of acoustic signals, by pivoting the sensor and searching for a local maximum sound level. The target laser marks the approximate position of the damaged area.

The LED light serves as a torch light, making it easier to search for damaged areas in poorly lit environments.

### 3.4 Sensor construction

Operating elements

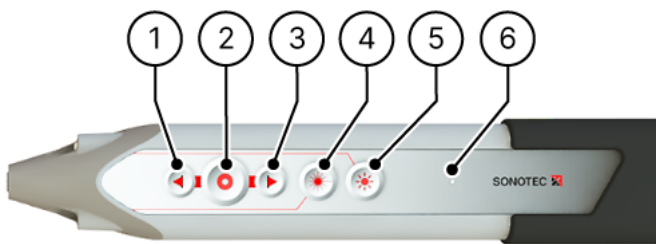

Figure 1: Operating elements of the BS10

No.	Description/function
1	Increases the volume of the acoustic playback.
2	Starts/stops a measurement value recording.
3	Decreases the volume of the acoustic playback.
4	Switches on the target laser (keep the button pressed)
5	Switches the LED light (torch light) on or off
6	Status LED <ul style="list-style-type: none"> <li>Constantly lit: sensor is activated</li> <li>Flashing: sensor is in boot mode</li> </ul>

ⓘ Boot mode is required for sensor firmware updates.  
(see [Updating sensor firmware with the SONAPHONE Hardware Manager app](#))

## Sensor elements

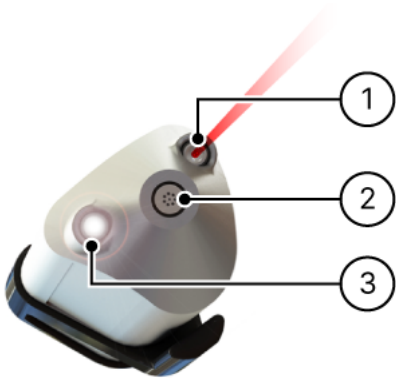

Figure 2: Sensor elements of the BS10

No.	Description/function
1	Target laser (laser class 2)
2	Ultrasonic microphone
3	LED light (torch light)

## Connections

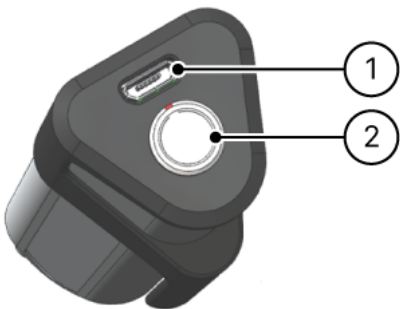

Figure 3: Connections of the BS10

No.	Description/function
1	USB port <ul style="list-style-type: none"><li>Type: Micro-USB socket, type B</li><li>for service purposes only</li></ul>
2	Sensor cable socket <ul style="list-style-type: none"><li>Type: LEMO 0B (4-pin)</li><li>with marked plug-in position</li></ul>

### 3.5 Sensor identification

Identification plate

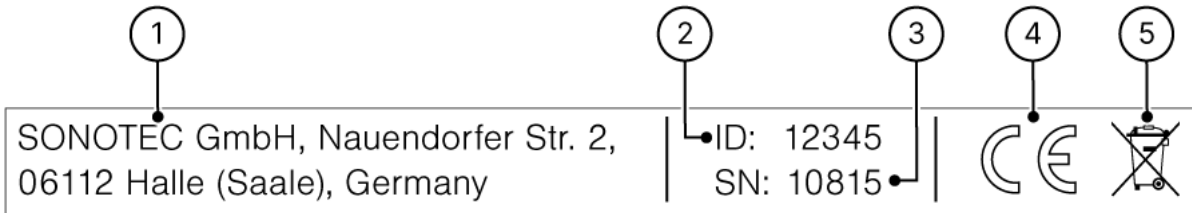

Figure 4: Identification plate with its components

No.	Identification
1	Manufacturer's address
2	Sensor ID
3	Serial number
4	CE marking
5	Disposal symbol (see "7 Disposal", page 21)

Laser class identification



### 3.6 Accessories

Intensity and behavior of ultrasonic signals depend on factors such as the process during which they are generated. Measurement value recordings with high signal quality are necessary for valid conclusions on system conditions. Signal quality also depends on a number of factors.

In order to guide high-quality signals to the sensor's ultrasonic microphone, the following attachments are available for different applications.

#### 3.6.1 Small acoustic horn BS10-2



---

Application	For close-range detections
Article number	400 01 0145

---

#### Description

The small acoustic horn BS10-2 is used as the standard attachment on BS10. This attachment provides the sensor with a directivity for close-range applications. A relatively large opening angle allows for simple detection of ultrasound sources in the room. Use the target laser to narrow down the area for subsequent precise location.

### 3.6.2 Large acoustic horn BS10-3



Application	For detections within a range of up to 8 m
Article number	400 01 0148

#### Description

The large acoustic horn BS10-3 increases the directivity of the sensor compared to the small acoustic horn BS10-2. The opening angle decreases while the sensitivity increases. This means detection of ultrasound sources becomes possible for larger distances. Background noise of other ultrasound sources within the room can easily be distinguished from the sound source to be detected. Use the target laser to narrow down the area for subsequent precise location.

### 3.6.3 Precise locator BS10-1



Application	For precisely locating ultrasound sources
Article number	700 01 0296

#### Description

The precise locator BS10-1 directs the sensitive opening of the sensor to a small circular area. This means that wide range and directivity are lost. In return, it is possible to search for an ultrasound source directly on the surface of a test object. For detection, the tip may be turned in the direction of the damaged area. Thus, it is possible to differentiate between sound sources that are close to each other and to identify defective components.

## 4 Operation of the sensor

This section contains descriptions and instructions for operating the sensor and using it in combination with the SONAPHONE handheld unit.

### ▲ WARNING

#### Risk of injury to eyes by target laser!

The target laser (laser class 2) can cause serious eye damage.

- Never look into the laser beam.
- Never direct the laser at other people or vehicles.
- Keep in mind that in the event of ongoing exposure, even reflected laser light might cause eye injuries.

### 4.1 Assembling or disassembling the sensor attachments

#### ATTENTION

#### Risk of faulty readings due to wrongly installed sensor attachments!

Crooked or loosely mounted sensor attachments may lead to faulty readings and/or influence the directivity characteristics of the target laser.

- Always make sure to mount the sensor attachments securely in a tight and straight manner.

#### Mounting

1. Hold the sensor with one hand and move the sensor attachment on the sensor with the other hand until the sensor attachment perceptibly locks in place.

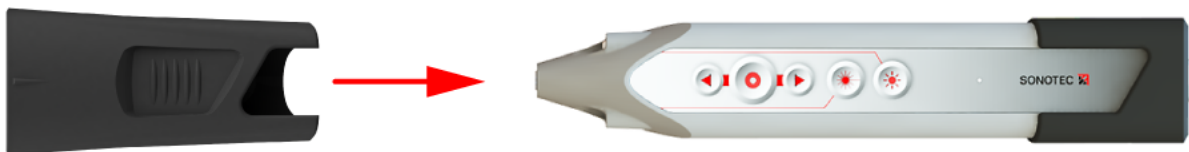

#### Removal

1. Hold the sensor with one hand and pull the sensor attachment from the sensor with the other hand.

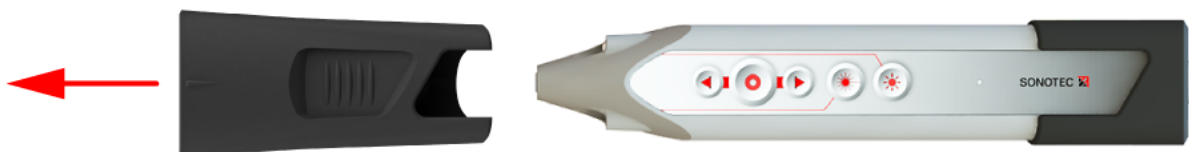

## 4.2 Connecting the sensor

### ATTENTION

#### Risk of damage to sensor and/or sensor cable!

When connecting the sensor, always mind the red markings on the sockets of the sensor and the SONAPHONE handheld unit as well as the sensor cable.

1. Connect the sensor to the SONAPHONE handheld unit via the sensor cable.



→ The SONAPHONE handheld unit provides power to the sensor.

→ As soon as the status LED of the sensor is constantly lit, the sensor is ready for use.

ⓘ During measurements, the measurement data will be transferred automatically from the sensor to the SONAPHONE handheld unit.



### 4.3 Operation via sensor buttons

Measurements may be controlled either via the touch screen of the SONAPHONE handheld unit or the sensor buttons. The sensor buttons provide the following functions:

- Increasing the acoustic playback volume



- Starting or stopping the measurement value recording



- Decreasing the acoustic playback volume



- Switching on the target laser (keep the button pressed)



- Switching the LED light on or off



## 5 Cleaning and maintenance

### 5.1 Cleaning

#### Guidelines

Do not open the product! The product contains no parts to be cleaned by the operator.

#### **ATTENTION**

##### **Risk of damage of the ultrasonic microphone!**

The ultrasonic microphone may be damaged during sensor cleaning.

- Do not let detergent enter the ultrasonic microphone.
  - Avoid mechanical stress on the ultrasonic microphone.
- 

#### Suitable cleaning products

Only clean the product on the outside with soft, lint-free cloth.

#### **ATTENTION**

##### **Check the compatibility of used cleaning agents!**

The compatibility of all cleaning agents with used materials and colors must be confirmed and approved by SONOTEC GmbH or the respective supplier.

---

#### Unsuitable cleaning agents

Do not clean the product with:

- scratchy, aggressive, solvent-containing or benzine-containing cleaning agents,
- pressured air, high-pressure cleaner or other kinds of cleaning machine.

#### After cleaning

After cleaning the device, make sure that:

- cables, connectors and fittings are free of cleaning agents and
- cables, wires, connectors and electrical components are dry.

### 5.2 Maintenance

#### Guidelines

Do not open the device! The device contains no parts to be maintained or repaired by the operator.

## 6 Technical data

### General data

<b>Article number</b>	200 01 0299
<b>Dimensions (L × W × H)</b>	see technical drawing
<b>Weight</b>	80 g (without accessories)
<b>Electrical connection</b>	LEMO 0B (4-pole)

### Acoustic data

<b>Frequency range</b>	15 ... 100 kHz
<b>Measurement resolution</b>	1 dB

### Materials

<b>Housing material</b>	Polycarbonate/ABS
-------------------------	-------------------

### Ambient conditions

<b>Operating temperature</b>	-10 ... +65 °C (according DIN EN 60068-2-2:2008-05)
<b>Storage temperature</b>	-20 ... +65 °C (up to 40 °C at 90 % humidity according to DIN EN 60068-2-78:2014-02)
<b>Protection type</b>	IP40

### Order details

<b>Scope of delivery</b>	<ul style="list-style-type: none"><li>• Broadband airborne sound sensor BS10</li><li>• Calibration certificate</li></ul>
--------------------------	--------------------------------------------------------------------------------------------------------------------------

Technical drawing

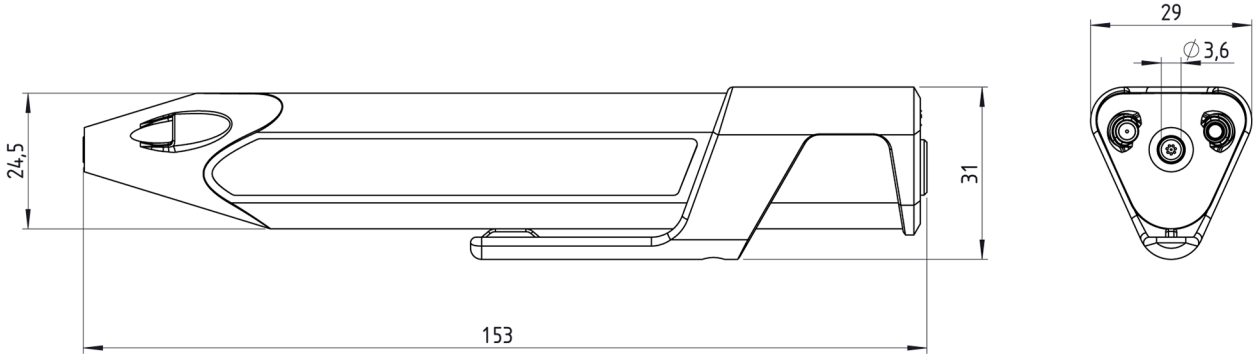

## 7 Disposal

### Recycling and taking back of used equipment

Electrical and electronic devices may pose a risk to health and the environment if disposed of incorrectly. They cannot therefore be disposed of as domestic waste according to WEEE Directive 2012/19/EU (Waste Electrical and Electronic Equipment Directive). Instead they must be taken to designated collecting points or returned to the manufacturer.

The following symbol indicates the legal duty to dispose of electronic devices as stipulated.

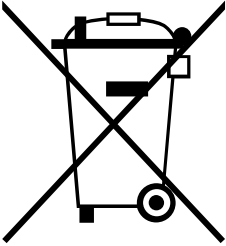

They must undergo specified recycling processes (e. g., with respect to batteries or circuit boards) which enable safe, environmentally compatible re-use or separate disposal of different device elements.

The return of used devices is regulated differently in different places. Find out from your local council about the return conditions for commercially used electronic devices. The device, including rechargeable battery, contains no toxic substances requiring separate identification for disposal such as mercury (Hg), cadmium (Cd), lead (Pb) or chrome 6 (e. g., in plated parts or circuit boards).

## 8 Warranty

### Condition at delivery

All products and accessories have been tested thoroughly before they leave the factory, are state-of-the-art products at the time of delivery and adhere to all applicable safety regulations.

### Warranty

During the warranty period, SONOTEC GmbH will eliminate all deficiencies caused by material or manufacturing faults free of charge. SONOTEC GmbH will at its own discretion offer warranty by reparation or replacement of faulty products.

### Exceptions

Internal accumulators as well as damage caused by unintended use, by wear or by manipulation of the product are exempt from warranty. The warranty also does not cover those faults that affect value or usability of the product to a negligible amount.

### Responsibility of the user/operator

It lies within the responsibility of the users to ensure that the product has been installed and set-up properly and is used in a manner that does not impair safe operation.

### Operating errors

Operating errors can never be completely ruled out by the manufacturer. SONOTEC GmbH is in no way liable for any direct or indirect damage caused by operating errors (e.g. damage on software and/or hardware, damage by downtime, damage by malfunction as well as damage or loss of measurement and test data).

### Quality of captured data

The determination of valid test results, their interpretation and the actions derived therefrom are exclusively subject to the personal responsibility of the users. SONOTEC GmbH does not guarantee the correctness of determined test values and/or test results. SONOTEC GmbH does not assume liability for any faults or damages that might occur due to further use of determined test and measurement values.

## 9 Manufacturer information

### Copyright

© SONOTEC GmbH

All rights reserved.

All contents of this document are property of SONOTEC GmbH and are protected by copyright. Duplication, modification and/or distribution in any form, particularly for reprint, for photographic, mechanical or electronic reproduction or in the form of saving in data processing systems or data networks is forbidden without written approval by SONOTEC GmbH.

### Certifications and registrations

- Quality management according to ISO 9001:2015  
(Certificate Registration No.: 091006014)
- Registration according to ElektroG at the 'stiftung elektro-altgeräte register' (ear):  
WEEE Reg. No. DE 22125904

### Contact

#### **Manufacturer**

SONOTEC GmbH  
Nauendorfer Str. 2  
06112 Halle (Saale), Germany  
Phone: +49 345 13317-0  
[mySONAPHONE@sonotec.de](mailto:mySONAPHONE@sonotec.de)  
[www.sonotec.eu](http://www.sonotec.eu)

#### **USA**

SONOTEC US Inc.  
190 Blydenburgh Rd.  
Suite 8, 2<sup>nd</sup> Floor  
Islandia, New York 11749, USA  
Phone: +1 631 4154758  
[sales@sonotecusa.com](mailto:sales@sonotecusa.com)  
[www.sonotecusa.com](http://www.sonotecusa.com)