



## Operating Manual

# SONAPHONE

Ultrasonic testing device for preventive maintenance

Translation of the German original

Revision: 2.0 | 2023-04-03

# Content

<b>1</b>	<b>Notes on this documentation</b>	<b>4</b>
1.1	General	4
1.2	Representations in this documentation	4
1.3	Identification of warning instructions	5
<b>2</b>	<b>Safety instructions</b>	<b>6</b>
2.1	Introduction	6
2.2	Basic hazards	6
2.3	Personnel and qualifications	7
2.4	Safety-conscious working practices	8
2.5	Use of the product	9
2.6	Modifications and alterations	10
2.7	Data security	10
<b>3</b>	<b>Description of the device</b>	<b>11</b>
3.1	Intended use	11
3.2	Prohibited use	11
3.3	Range of functions	12
3.4	Working principle	13
3.5	Device labeling	14
3.6	Connections, interfaces, device elements	15
3.7	Status display and device buttons	17
3.8	Home screen	19
3.9	SONAPHONE Software	20
3.10	Operating keys of the headphones	21
<b>4</b>	<b>Commissioning</b>	<b>22</b>
4.1	Charging the battery	22
4.2	Fastening the carrying strap to the device	23
4.3	Switching the device on/off	25
4.4	Setting user interface language, date and time	26
<b>5</b>	<b>Managing SONAPHONE apps</b>	<b>28</b>
5.1	Internet portal "mySONAPHONE.com"	28
5.2	Installing or updating	28
5.3	Uninstalling and removing	29
<b>6</b>	<b>Preparing a work order</b>	<b>30</b>
6.1	Starting the app	30
6.2	Adjusting the display brightness	30
6.3	Connecting the sensor	31
6.4	Using headphones	33
6.5	Adjusting the volume	34
<b>7</b>	<b>Performing measurements</b>	<b>36</b>
7.1	Using SONAPHONE apps	36

7.2	Creating screenshots.....	37
<b>8</b>	<b>Concluding a work order.....</b>	<b>38</b>
8.1	Reading PDF files on the device.....	38
8.2	Hiding or closing an app.....	39
<b>9</b>	<b>Managing data.....</b>	<b>40</b>
9.1	Directory structure.....	40
9.2	Transferring data from the device to a PC.....	41
9.3	Using the microSD card.....	41
<b>10</b>	<b>Using SONAPHONE DataSuite.....</b>	<b>43</b>
10.1	Managing data.....	43
10.2	Collecting data.....	43
<b>11</b>	<b>Cleaning and maintenance.....</b>	<b>44</b>
11.1	Cleaning.....	44
11.2	Maintenance.....	45
<b>12</b>	<b>Troubleshooting.....</b>	<b>47</b>
<b>13</b>	<b>Technical data.....</b>	<b>48</b>
<b>14</b>	<b>Disposal.....</b>	<b>50</b>
14.1	Recycling and taking back of used equipment.....	50
14.2	Removing the battery.....	51
<b>15</b>	<b>Warranty.....</b>	<b>53</b>
<b>16</b>	<b>Manufacturer information.....</b>	<b>54</b>

# 1 Notes on this documentation

## 1.1 General

### Purpose

This documentation constitutes an integral part of the product and contains important advice on safe operation as well as all information on intended and efficient use. Thus, any person using the product must have read and understood this documentation.

### Accessibility

The staff working with this product must have constant access to this documentation to prevent handling errors and guarantee trouble-free operation.

### Up-to-dateness

Every effort has been made to ensure that the information contained in this documentation is complete and correct at the time of release. This documentation describes all units and functions known of at the current point of time.

## 1.2 Representations in this documentation

### Illustrations

Illustrations used in this document do not always contain all details or special cases. They only represent the relevant information.



### Tips

Tips are marked as follows:

 Tips describe specific information or particular features that might not be evident, even for experienced users. The neglect of a tip poses no direct safety risk. However, it can lead to workflow disruptions.

### General icons

The following general icons are used for visual emphasis:

Icon	Function
	Indicates a link to external content.
	Indicates the use of a tool.

---

## 1.3 Identification of warning instructions

Classes of danger, signal words and colors

This documentation contains warnings regarding hazards of different classifications. These classes are characterized by signal words and colors. They include the following:

### **▲ WARNING**

Warns of possible immediate danger, which, if ignored, may lead to lasting damage to health and/or property - including financial losses due to operational impairment.

---

### **ATTENTION**

Warns of dangers, which, if ignored, may lead to damage to property – including damage to property due to operational interruptions.

---

## 2 Safety instructions

This section contains safety information relating to the protection of persons as well as safe and fault-free operation. All user groups of the product must be aware of and follow these safety provisions.

### 2.1 Introduction

Reliable and safe operation of the product depends on the careful handling and execution of operational and setting tasks.

Ignoring these safety instructions and warning information may lead to serious injury with lasting health consequences for personnel as well as damage or destruction of product components.

During handling of the product, please observe all safety instructions and warning information in all parts of this user documentation as well as the related codes of practice. Ensure that all those working with the product are also aware of these instructions.

Generally applicable safety regulations (such as accident prevention and environmental protection regulations, etc.) must also be observed.

### 2.2 Basic hazards

#### Definition

Basic hazards are residual risks that remain even with safety-conscious intended use.

#### State of the art

The product meets the current state of the art and applicable safety rules. All components of the product are tested thoroughly before they leave the factory and are delivered in a condition for safe operation.

#### **▲ WARNING**

##### **Danger of injury!**

Improper use of the device may lead to injuries.

- Do not open the device.
  - Protect the device against extreme heat (excessive sunlight, immediate vicinity of open fire or heating devices) during operation and storage.
  - Avoid strong impacts that could damage the device and/or its components.
-

## ATTENTION

### **Possible damage of the device display!**

Improper use may damage the device display.

- Do not use scratching or sharp objects to operate the device by touch screen. Commercially available pens for touch screens are suitable.
- 

## 2.3 Personnel and qualifications

### Basic requirements

The product must only be used by operators that have completely read and understood the safety instructions and all documents of the user documentation.

Personnel undergoing training or instructions or persons taking part in general vocational training programs may only operate the device under the continuous supervision of operating or technical personnel.

### Responsibility of the operating company

Regarding the personnel authorized and/or trained by the operating company, the operating company carries the following responsibilities:

- The necessary training and instruction of personnel must be guaranteed.
- All personnel's competences and responsibilities must be clearly stated and documented.
- All user information on the product (operating manual, user documentation etc.) must be kept in the immediate vicinity of the product and must be accessible at all times.

### Requirements on ultrasonic testing

Operators of the device must have thorough expertise, skills and experience to avoid errors that may lead to unforeseeable consequences.

Ultrasonic testing with the SONAPHONE may only be carried out when the following (minimum) conditions are met:

- Selection of suitable accessories
- Complete and correct configuration of the device parameters
- Selection of a suitable testing method
- Correct interpretation of measurement values
- Expertise for drawing conclusions on the condition of the plant.

## 2.4 Safety-conscious working practices

### Accident prevention and environmental protection

In addition to the instructions in this operating manual, please mind the generally applicable legal and other regulations on accident prevention and environmental protection.

This may include, for example:

- Handling of hazardous materials
- Wearing the required and mandatory personal protective clothing and safety equipment
- Observing of and complying with all national and regional industrial safety regulations
- Observing of and complying with all internal working, operating and safety regulations



## 2.5 Use of the product

### Measures for personal safety

Improper use of the product may lead to injuries of operating personnel.

- During detection of ultrasonic signals on electrical equipment, make sure to keep the mandatory safety distance from detected electrical defects.
- Always make sure that both hands are free for self-protection, if necessary.
- Always make sure to keep your hands, the product and/or connected equipment within your field of vision.
- Use the torchlight functionality (LED light) of the product and/or additional lighting to illuminate test sites with poor visibility.
- Always use the product without distraction. Do not read messages on the display and/or operate the product while walking.
- Carry the device by the carrying strap when climbing up and down ladders and stairs. Always carry the device by the carrying strap in such a way that the carrying strap does not get caught or entangled in moving parts.

### Measures for protection of the product and/or equipment

Improper use of the product may lead to product damage. Damaged components may affect or distort the measurement result quality.

- During use, charging and storage, protect the device against extreme, unusual heat (excessive sunlight, storage in heated cars or immediate vicinity of open fire or heating devices). It is critical to stay within the temperature ranges given in the technical specification.
- Do not use the product and its accessories if they display functional errors and/or visible damage.
- Only connect the product to approved equipment received from SONOTEC GmbH or its sales partners.
- The product adheres to the protection class given in the technical specification and is not protected against water. Do not submerge the product in liquids. Protect the product against moisture penetration.
- Handle the product with care and protect it against major shocks. Use the carrying case to transport and store the product.
- When using the product, always make sure that cables cannot get stuck and/or caught in moving parts.
- Do not use the product within strong electromagnetic fields.
- Do not use scratching or sharp objects to operate the touchscreen. Apart from operation by finger touch, commercially available touchscreen pens or touchscreen gloves are suitable.

## 2.6 Modifications and alterations

No modifications on the product and/or accessories

The product and/or its accessories must not be opened or disassembled. The product does not contain any components to be cleaned, maintained or repaired by operators.

Unauthorized modifications of the product and/or its accessories are prohibited and lead to exclusion of liability by the manufacturer for resulting damage and consequences.

Spare parts and accessories

Spare parts and accessories must comply with the technical requirements specified by SONOTEC GmbH and its suppliers. Whenever original parts are used, compliance is given.

No alterations to the software

Do not alter the supplied software or commission software alterations to third parties. The software may not be disassembled, decrypted or decompiled in full or in part.

## 2.7 Data security

Data loss

The loss of measurement data may lead to incomplete measuring chains or misinterpretations.

- Always make sure to backup measurement data regularly on external data media.
- Back up your measurement data before updating the software or resetting the device to factory settings.

Cyber security measures

Based on analysis of vulnerabilities according to IEC 62443-4-1 and IEC 62443-4-2, no cyber security measures are necessary for the product.

However, a cyber attack on the product and its environment can never be completely ruled out. Thus, we strongly recommend to implement safety measures (e.g. anti-virus programs, firewalls, access restrictions) against potential cyber attacks within the product environment.

## 3 Description of the device

This section describes use, connections and controls of the SONAPHONE.

### 3.1 Intended use

The SONAPHONE is a testing device for the verification, recording and evaluation of ultrasonic signals.

Ultrasound can be created during a wide range of processes, including:

- at leaks in compressed air, steam and vacuum systems,
- during the operation of steam traps,
- at leaking valves, gates, barriers or taps in pipe systems,
- during the normal function of slide or rolling bearings,
- during cavitation caused by pumps and compressors,
- in the event of flashovers or corona discharges in electrical systems.

Depending on the device version and equipment, there are many other possible applications for the device for processes where ultrasonic signals can be verified.

### 3.2 Prohibited use

Any use not approved by SONOTEC GmbH is prohibited and may lead to injury or damage to property.

SONOTEC GmbH accepts no liability for damage caused by prohibited use of the product.

Prohibited are in particular:

- Use of equipment and/or accessories with visible damage
- Use in wet rooms
- Use in potentially explosive environments
- Use in environmental conditions that do not adhere to the stipulated requirements
- Unauthorized modifications of the equipment, the software and/or accessories
- Use of unauthorized spare parts and/or unauthorized accessories

Operating or using the product incorrectly and/or not in the sense of its intended use may lead to risk of death and personal injury.

### 3.3 Range of functions

The SONAPHONE can be used for the evaluation of system conditions wherever ultrasonic signals are created and wherever the evaluation of these signals allows for conclusions to be drawn regarding correct functioning. Applications range from "simple" leak detection through to monitoring tasks for complex processes.

The device concept of the SONAPHONE has been developed to support the user with evaluation for a range of different processes by means of an adapted sensor system and flexibility in the output of the recorded data.

The basis of the system is the mobile testing device, which has various sensor connections and interfaces. Function and application software is installed on the device. The LevelMeter app (basic version) already includes functionalities for testing, recording and display.

With this, many basic tasks can already be realized:

- Planning testing work
- Recording signal curves
- Saving and playing back signal curves
- Making ultrasonic signals audible
- Documenting (photographing) test points and marking damage areas

For special tasks, the system can be expanded by the addition of the following:

- Sensors that meet the special requirements of the testing work
- Application-specific software with extended functions allowing for the recording, evaluation and management of testing and measurement data for special tasks.

### 3.4 Working principle

For a variety of different processes, ultrasonic signals are created in different frequency ranges, which the SONAPHONE makes visible and audible:

For tests carried out with the SONAPHONE, a distinction is made between two types of ultrasound with regard to the use of sensors:

Airborne sound – these sound waves spread via air, and can be verified in leak detection on compressed air lines, for example.

Structure-borne sound – these sound waves occur in mechanical processes, spread via solid structures, and can be used to verify bearing wear, for example.

The SONAPHONE can be used to evaluate ultrasonic signals that inevitably occur in the observed processes (leaks in compressed air or vacuum systems).

Alternatively, the SONAPHONE can be used to record ultrasonic signals that are actively generated by a corresponding transmitter. This procedure is used for leak detection in non-pressurized systems and containers, for example.

The level curve is depicted by averaging the ultrasound with very short time intervals. The level data is output in the form of a level graph. The spectra are calculated directly from the high-resolution ultrasound data, and are displayed as a function of time (spectrograms). Up to 5 additional level values can be output via the display in order to meet individual requirements.

At the same time, the signals are made audible via the integrated speaker or the headphones (for working in areas with high levels of background noise). The volume can be adjusted using the buttons on the device or on the sensors.

For documentation purposes, voice memos can be recorded for each test, and text comments can be added. Photos can also be taken, with damage areas marked.

The saved data and additional information can be used to create PDF reports within the device. There is also the option of transferring all data (individual data as well as reports) to other devices for further processing via the USB interface.

Extended functionalities are possible in the form of adapted sensors and the associated special software (see relevant documentation).

### 3.5 Device labeling

#### Identification plate

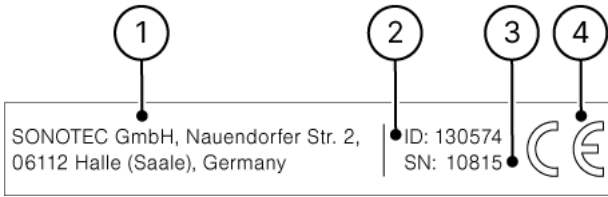

No.	Identification
1	Manufacturer's address
2	Model ID
3	Serial number
4	CE marking

#### Disposal

The marking for disposal is located on the battery cover:

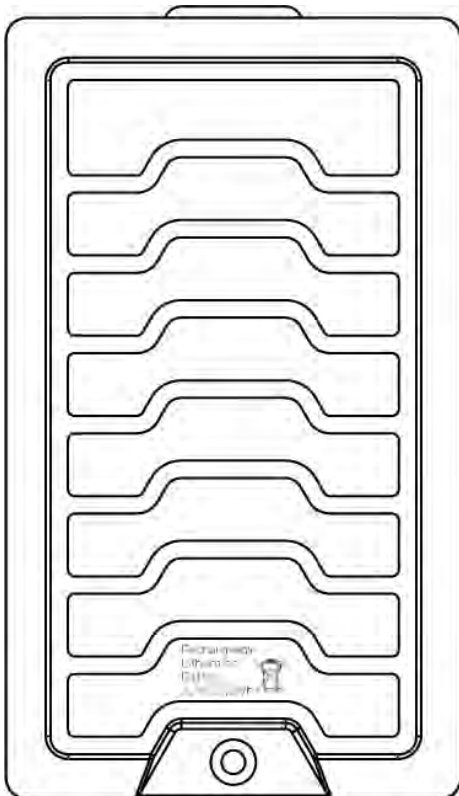

### 3.6 Connections, interfaces, device elements

#### Structure

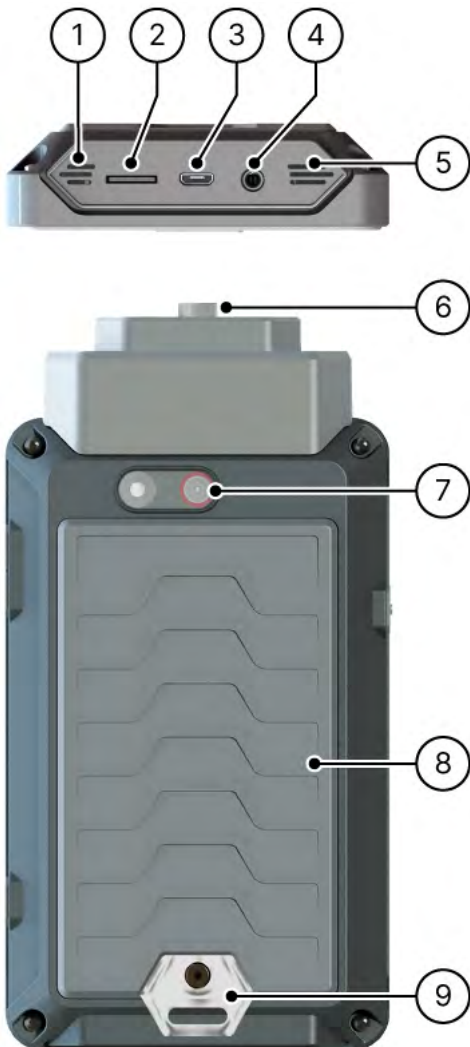

#### Description

No.	Connection/interface/device element
1	Microphone
2	Slot for micro SD card
3	USB port <ul style="list-style-type: none"> <li>Type: Micro-USB socket, type B</li> <li>for charger / power supply / data transfer</li> </ul>
4	Headphone jack (jack socket 3.5 mm)

No.	Connection/interface/device element
5	Speaker
6	Sensor cable socket <ul style="list-style-type: none"><li>• Type: LEMO 0B (4-pin)</li><li>• with marked plug-in position</li></ul>
7	Camera and flash
8	Battery with cover
9	Carrying strap bracket



### 3.7 Status display and device buttons

#### Structure



#### Description

No.	Component	Description/function
1	Status LED SONAPHONE	Shows the current device status: <ul style="list-style-type: none"> <li>• <b>Green:</b> Device is starting.</li> <li>• <b>Red:</b> Measurement value recording is active.</li> </ul>
2	Status-LED state of charge	Shows the current state of charge: <ul style="list-style-type: none"> <li>• <b>Orange:</b> Battery is charging.</li> <li>• <b>Green:</b> Battery is charged.</li> </ul>
3	Increase volume	Increases the volume of the acoustic playback.
4	Decrease volume	Decreases the volume of the acoustic playback.

No.	Component	Description/function
5	Configurable hardware button	<p>Activation/deactivation of the display lock when tilting or turning the SONAPHONE handheld unit.</p> <div style="border: 1px solid black; padding: 5px;"><p>ⓘ If the display lock is activated, it may be deactivated by pressing the hardware button.</p></div> <p>The assignment of the hardware button can be set in the SONAPHONE apps.</p>
6	Home button	<ul style="list-style-type: none"><li>• <b>Short pressing:</b> Switches to the home screen.</li><li>• <b>Long pressing:</b> Opens the overview of active apps.</li></ul>
7	On/Off button	<ul style="list-style-type: none"><li>• <b>Keeping pressed (2 s):</b> Turning the device on or off.</li><li>• <b>Short pressing:</b> Activate/deactivate standby mode.</li></ul>

---

## 3.8 Home screen

### Structure



### Description









No.	Description/function
1	Status bar: Shows volume, charge level and time. <div style="border: 1px solid black; padding: 2px; margin-top: 5px;">                     ⓘ With a swipe gesture from top to bottom, further information/settings can be displayed.                 </div>
2	Time and date (digital clock widget)
3	Quick access (up to 6 apps can be placed)
4	Opens the overview of all installed apps and widgets.
5	<b>Multitasking:</b> Opens the overview of active apps.
6	<b>Home:</b> Closes the current window and shows the home screen (activated apps remain active).
7	<b>Back:</b> Closes the current screen and returns to the previous one.

## 3.9 SONAPHONE Software

### Operating system

The SONAPHONE's operating system is based on Android 4.4.2. The source code can be disclosed upon request.

### SONAPHONE Apps

Icon	Name	Application
	Software Manager	App to manage (install, update, uninstall) SONAPHONE apps and app licenses. Factory pre-installed
	Hardware Manager	Highly specialized app for updating the firmware of SONAPHONE sensors BS10, BS20, BS30 and BS40 Factory pre-installed
	SONAPHONE Setup	Quick setting for interface language, date and time Factory pre-installed
	Measurement Core	Measurement core app Factory pre-installed
	LevelMeter	Versatile app for essential maintenance tasks Factory pre-installed
	SteamExpert	Highly specialized app for testing steam traps Optional
	LeakExpert	Highly Specialized App for localization and documentation of compressed air leakage Optional
	AssetExpert	Highly specialized app for route-based data collection Optional

### Licenses for third-party software

Licenses for third-party software used in the respective SONAPHONE apps can be displayed in the corresponding SONAPHONE app.

### 3.10 Operating keys of the headphones

ⓘ Always observe the manufacturer's original operating manual and the applicable instructions for safe working with ear protection in noisy areas.

#### Structure



#### Description

No.	Description/function
1	Switch headphones on/off: Press key for approx. 3 seconds, sound signal indicates operation/switching off
2	Increase noise reduction (play back ambient noise more quietly)
3	Reduce noise reduction (play ambient noise louder)

## 4 Commissioning

### 4.1 Charging the battery

The device is shipped with a partially charged battery. If the battery becomes discharged as a result of transport or use of the device, charge it using the supplied power supply unit.

ⓘ When the battery is fully discharged and the device is switched off, a charging process takes approx. 4 hours.

1. Connect the device to the power supply via the power supply unit.
  - The "State of charge" status LED lights up orange.
  - When charging is complete, the "State of charge" status LED lights up green.

## 4.2 Fastening the carrying strap to the device

Mounting the carrying strap bracket

The carrying strap bracket is pre-assembled. If this is not the case, proceed as follows:

1. Use the Allen key (included in delivery) to loosen and remove the cylinder head screw of the battery cover.



2. Fasten the carrying strap bracket with the supplied countersunk screw and tighten it hand-tight with the Allen key.



### ATTENTION

**Insufficient securing of the carrying strap possible by using the wrong screw!**

Always use the countersunk screw to mount the carrying strap bracket.

### Attaching the carrying strap

1. Loosen the end of the carrying strap from the adjustment buckle.
2. Pull the adjustment buckle to a position where the end of the strap is long enough to be attached to the carrying strap bracket.
3. Place the carrying strap on the red side so that the backs of the adjustment buckles are visible.



4. Position the device so that the carrying strap bracket is facing up and thread the strap through the carrying strap bracket from top to bottom.
5. Push the end of the strap through both openings of the adjustment buckle and tighten the end of the strap.



6. Check that the carrying strap is firmly attached to the carrying strap bracket.



## 4.3 Switching the device on/off

### Switch on

1. Press and hold the On/Off button for approx. 3 seconds.



- The boot screen is displayed. The status LEDs light up.
- The device is started up.
- After starting up the device, the lock screen is displayed.

### Switch off

1. Press and hold the On/Off button for approx. 2 seconds.
  - A menu opens
2. Tap the **Power off** menu item.
  - The Power off dialog window opens.
3. Tap the **OK** button.
  - The device is shut down.

## 4.4 Setting user interface language, date and time

After the first power on

After switching on the device for the first time, the interface language, date and time must be set.

### ATTENTION

#### Mind the correct configuration of date and time!

The date and time configured in the device will be used in file names and/or as metadata when saving measurements and creating screenshots.

- Before each work order, check the correct setting of date and time within the device.

1. Switch on the device.
2. Unlock the lock screen.



→ The „Welcome“ screen opens.



3. Select the user interface language (1).
4. Set the date and time (2).
5. Tap the Apply“ (✓) icon.

→ The welcome screen closes and will not be displayed on subsequent device starts.

Adjust subsequently

The user interface language, date and time can also be subsequently adjusted in the device settings while the device is in use:

1. In the home screen, tap the “Overview” (☰) icon.
2. Open the “Settings” app.
3. In the menu item **Language & input**, select the particular user interface language.
4. In the menu item **Date & time**, adjust the date and time.

## 5 Managing SONAPHONE apps

Installation files can be transferred to the device via USB interface. SONAPHONE apps and licenses are managed with the “Software Manager” app.

### 5.1 Internet portal “mySONAPHONE.com”

Owners of the device can register on the Internet portal “mySONAPHONE.com” with the serial number of the device. After registration, updates and trial versions of SONAPHONE apps are available free of charge.

Registration: <https://www.sonotec.eu/en/mysonaphonecom/register/>

### 5.2 Installing or updating

File types

The following files are provided for installing or updating SONAPHONE apps:

- License files: \*.lic (to unlock an installed trial version)
- Installation files: \*.apk

Preparation

1. Download the installation file from the Internet portal “mySONAPHONE.com” to the PC.
2. Download the license file to the PC.

ⓘ The link for downloading the installation file will be sent by email after purchase of the license.

3. Connect the device to the PC with a USB cable.
4. Copy the installation and/or license file from the PC to the device directory **Internal memory > Sonaphone**.

Performing installation/update on the device

1. In the home screen, tap the “Overview” (☰) icon.
2. Open the “Software Manager” app.
3. Tap the “Install” (↓) or “Update” (↻) icon of the particular app.
4. Follow the instructions in the installation wizard.

ⓘ **Installing the license file subsequently**

If a license file for a previously installed trial version of an app is subsequently copied to the device, the license file must be installed by tapping the “Update” (↻) icon of the corresponding app.

After installing the license, the app is unlocked as a full version.

## 5.3 Uninstalling and removing

Unnecessary or unused apps can be uninstalled and removed from the device if necessary.

ⓘ When uninstalling, only app-specific basic settings (e.g. set user name) are reset. The measurement data recorded with the app is retained. After reinstalling an app, the previously recorded measurement data is available again.

### Uninstalling an app

1. In the home screen, tap the “Overview” (☰) icon.
2. Open the “Software Manager” app.
3. Tap the “Uninstall” (🗑️) icon of the particular app.

### Removing an app installation file from the device

After uninstalling an app, the installation file of the app (\*.apk) can be removed from the device.

1. Uninstall the app.
2. In the “Software Manager”, tap the “Delete” (✖) icon of the particular app.

## 6 Preparing a work order

In diesem Bereich werden Vorbereitungen und Einstellungen beschrieben, die vor dem Bearbeiten eines Arbeitsauftrags notwendig und/oder sinnvoll sind, um belastbare und bewertbare Messdaten aufzuzeichnen und Messungen in übersichtlicher Form durchzuführen.

### 6.1 Starting the app

1. Navigate to the particular app on the home screen or in the overview of all apps.
2. Tap the icon of the particular app.



### 6.2 Adjusting the display brightness

A reduced display brightness can reduce the power consumption of the device and thus extend the runtime.

1. In the home screen, tap the "Overview" (⋮) icon.
2. Open the "Settings" app.
3. Open the **Display** menu item.
4. Tap the **Brightness** menu item.
5. Use the slider to set the desired brightness.

## 6.3 Connecting the sensor

### ATTENTION

#### Risk of damage to sensor and/or sensor cable!

When connecting the sensor, always mind the red markings on the sockets of the sensor and the SONAPHONE handheld unit as well as the sensor cable.

1. Connect the sensor to the SONAPHONE handheld unit via the sensor cable.







→ The SONAPHONE handheld unit provides power to the sensor.

→ As soon as the status LED of the sensor is constantly lit, the sensor is ready for use.

ⓘ During measurements, the measurement data will be transferred automatically from the sensor to the SONAPHONE handheld unit.

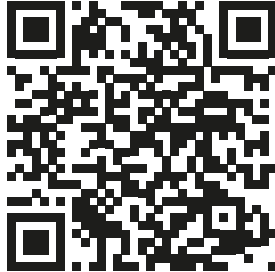
### Available sensors

Different types of SONAPHONE sensors are available depending on the work order/application. More detailed information on the function and use of the sensors can be found in the user documentation of the corresponding sensor:

SONAPHONE sensor	Type	QR code with link to online documentation
BS10	Broadband airborne sound sensor	
BS20	Broadband structure-borne sound and temperature sensor	
BS30	Broadband parabolic sensor	
BS40	Broadband structure-borne sound sensor	

---



## 6.4 Using headphones

### **▲ WARNING**

#### **Risk of hearing damage!**

Follow the manufacturer's operating instructions and all valid instructions for working safely with hearing protection in noise areas.

---

#### Connecting and operating

1. Connect the headphones to the SONAPHONE with the appropriate cable.
2. Press and hold the "On/Off" (⏻) button for approx. 3 seconds to switch on the headphones.  
→ A sound signal indicates that the headphones are switched on.
3. Use the "Plus" (+) or "Minus" (–) buttons to set the desired noise suppression.

#### Transporting

### **ATTENTION**

#### **Risk of damage to the cable connectors!**

When transporting and/or stowing the headphones in the carrying case, the headphone cable connectors may be damaged.

- Always disconnect the cable from the headphones before transporting and/or storing the headphones in the carrying case.
-

## 6.5 Adjusting the volume

When assessing machine or system states using the device, the interpretation of the converted audible ultrasonic signals plays a vital role (as well as the observation of the level indicators and the spectrogram).

Before starting the test, make sure that:

- the volume in the device and
- the suppression of ambient noise on the headphones

are set according to the ambient conditions.

### ⓘ Test auditory impression

Test the auditory impression in combination with the different display options for the respective app by generating active ultrasonic signals. (Airborne sound: rub your fingers together or blow into the airborne sound sensor; Structure-borne sound: carefully rub the tip of the structure-borne sound sensor on a hard surface).

### Adjusting the device volume

Use the volume buttons to set the volume at which the signals can be best evaluated via auditory impression.



## Setting suppression of background noise on headphones

The headphone settings can be adjusted in order to completely cancel out or gradually adjust any background noises, such as that from industrial equipment. If you are working in a team or training employees, you can adjust the headphone settings to allow for conversation without having to remove the headphones.

### **▲ WARNING**

#### **Risk of hearing damage!**

Follow the manufacturer's operating instructions and all valid instructions for working safely with hearing protection in noise areas.

---

Use the "Plus" (+) or "Minus" (–) buttons to select the setting that best evaluates the ultrasonic signals by auditory impression.

#### **ⓘ Safety function of the headphones**

The headphones have an automatic safety function. If there is a lot of background noise, the headphones will automatically reduce the background noise in order to protect the user's ears.

## 7 Performing measurements

For each work order, an individual measurement will be performed. As soon as measurement values have been collected, it is possible to document the measurement in detail with additional data.

Additional data may be added either directly after recording the measurement values or at a later point in time.

### 7.1 Using SONAPHONE apps

Measurements can be performed using the “SONAPHONE LevelMeter App” or a specialized app. More detailed information on performing measurements can be found in the user documentation of the corresponding app:

SONAPHONE app	QR code with link to online documentation
LevelMeter	
SteamExpert	
LeakExpert	

## 7.2 Creating screenshots

Screenshots can be helpful for documenting measurements in addition to the additional data. For example, current SONAPHONE app screens can be saved as images on the device and then used to analyze/evaluate measurements.

1. Press the “On/Off” and “Decrease volume” buttons at the same time.



→ A screenshot of the current screen is taken and saved on the device. (see „**Fehler! Verweisquelle konnte nicht gefunden werden. Fehler! Verweisquelle konnte nicht gefunden werden.**“ on page **Fehler! Textmarke nicht definiert.**)

## 8 Concluding a work order

Once all measurements have been taken and saved, they can be subsequently analyzed on the device or processed for further applications (e.g. PDF reports or editing in SONAPHONE DataSuite).

### 8.1 Reading PDF files on the device

To view PDF files (user documentation, PDF reports of SONAPHONE apps) on the device, the free Acrobat® Reader® app is installed.

ⓘ The Acrobat Reader App was developed by Adobe Systems and is not a SONOTEC product. Acrobat Reader is a registered trademark of Adobe Systems Software Ireland Limited. Further information under <https://www.adobe.com>.

Open Adobe Acrobat Reader app

1. In the home screen, tap the “Overview” (⊞) icon.
2. Open the “Acrobat Reader” app.  
→ The app starts and shows the list of recently used documents.

Open PDF files stored on the device

1. In the Acrobat Reader app, tap the “Local” tab.  
→ A list of all PDF files stored on the device (sorted by location) is displayed.
2. Scroll to the particular PDF file.
3. Tap the particular PDF file.

## 8.2 Hiding or closing an app

### Distinction

App ...	Description/function
Hiding	<ul style="list-style-type: none"> <li>The app is moved to the background.</li> <li>The app is still active and can be reopened quickly.</li> <li>User data (username, selected folders or applications, audio settings) are preserved.</li> </ul>
Closing	<ul style="list-style-type: none"> <li>The system memory required by the app is available for other applications.</li> <li>System stability is improved because the apps' processes do not influence each other.</li> </ul>

### Hiding

1. Tap the "Home" (🏠) or "Back" (⬅️) icon.  
→ The home screen opens.

### Closing

1. Tap the "Multitasking" (☰) icon.  
→ The overview of active apps opens.
2. Swipe the particular app from right to left.  
→ The app closes.

## 9 Managing data

The data generated in the work orders with the device can be transferred from the device to a PC and analyzed or further processed on the PC. The data generated includes:

- Measurement and additional data of the performed measurements,
- Photos taken with the camera app,
- - PDF reports and ZIP archives created with SONAPHONE apps,
- Screenshots,
- Log files of SONAPHONE apps

### 9.1 Directory structure

Internal memory of the device

The data relevant for work orders are structured on the device as follows:

Directory path	Data
Internal Memory > DCIM > Camera	Photos taken with the camera app (Format: JPG)
Internal Memory > Pictures > Screenshots	Screenshots created with the device (Format: PNG)
Internal Memory > Sonaphone	Installation and license files of the SONAPHONE Apps
Internal Memory > Reports	PDF reports and ZIP archives created with SONAPHONE apps <div style="border: 1px solid black; padding: 2px; margin-top: 5px;">① Each SONAPHONE app stores PDF reports and ZIP archives in its own subdirectory.</div>
Internal Memory > Logs	Log files generated by SONAPHONE apps <div style="border: 1px solid black; padding: 2px; margin-top: 5px;">① Each SONAPHONE app stores log files in its own subdirectory.</div>
Internal Memory > Routes	Route data of the SONAPHONE AssetExpert App <div style="border: 1px solid black; padding: 2px; margin-top: 5px;">① The directory is created when the SONAPHONE AssetExpert app is started for the first time.</div>



## MicroSD card

When a microSD card is inserted, SONAPHONE Apps can save measurement data directly to the card as PDF reports or in ZIP archives. The following directory is created on the microSD card:

### SD Card > Reports

ⓘ Each SONAPHONE app stores PDF reports and ZIP archives in its own subdirectory.

## 9.2 Transferring data from the device to a PC

The relevant data can be transferred from the internal memory of the device and/or the inserted microSD card to a PC.

### Via USB

1. Connect the device to the PC with a USB cable.
2. Navigate to the particular location (**Internal Memory** or **SD Card**) on the device.
3. Copy the particular data.
4. Paste the copied data into the particular location on the PC.

## 9.3 Using the microSD card

The SONAPHONE apps "LevelMeter", "SteamExpert" and "LeakExpert" can store measurement data as PDF reports and in ZIP archives to an inserted microSD card.

### Inserting the microSD card

1. Push the microSD card into the slot of the device until you feel it click into place.



→ The message "Preparing SD card" is displayed in the status bar.

## Safely removing the microSD card

### ATTENTION

#### **Risk of data loss and damage of the microSD card!**

Improper removal of the microSD card may result in data loss and/or damage to the card.

Do not remove the microSD card:

- while data is stored on the card and
- before you have safely removed the card from the device.

1. Make sure that the device is not connected to a PC via USB.
2. In the home screen, tap the "Overview" (⋮) icon.
3. Open the "Settings" app.
4. Open the **Storage** menu item.
5. Tap the **Unmount SD Card** entry.

ⓘ The entry is only active if the device is not connected to a PC via USB.

→ The Unmount SD card window opens.

6. Tap the **OK** button.

→ The message "SD card will be unmounted" is displayed.

7. Press on the microSD card in the slot until the lock is released.

8. Remove the micro SD card from the device.

→ The message "Removed SD card" is displayed in the status bar.

## 10 Using SONAPHONE DataSuite

The modular software platform SONAPHONE DataSuite is adding a central hub for the organization of maintenance processes. The software manages key planning, documentation and data analysis tasks and enables data exchange with multiple SONAPHONE handheld units.

### 10.1 Managing data

With the SONAPHONE DataSuite, measuring points can be organized according to a plant structure and grouped into routes.

More detailed information on function and use can be found in the user documentation:



[https://www.sonotec.de/doc/sonaphone/en\\_sonaphone\\_datasuite](https://www.sonotec.de/doc/sonaphone/en_sonaphone_datasuite)

### 10.2 Collecting data

The measuring points grouped in routes can be processed with the SONAPHONE handheld unit and the SONAPHONE AssetExpert App.

More detailed information on the function and use of the SONAPHONE AssetExpert app can be found in the user documentation:



[https://www.sonotec.de/doc/sonaphone/en\\_sonaphone\\_assetexpert](https://www.sonotec.de/doc/sonaphone/en_sonaphone_assetexpert)

## 11 Cleaning and maintenance

### 11.1 Cleaning

#### Guidelines

Do not open the product! The product contains no parts to be cleaned by the operator.

#### Suitable cleaning products

Only clean the product on the outside with soft, lint-free cloth.

#### **ATTENTION**

##### **Check the compatibility of used cleaning agents!**

The compatibility of all cleaning agents with used materials and colors must be confirmed and approved by SONOTEC GmbH or the respective supplier.

---

#### Unsuitable cleaning agents

Do not clean the product with:

- scratchy, aggressive, solvent-containing or benzine-containing cleaning agents,
- pressured air, high-pressure cleaner or other kinds of cleaning machine.

#### After cleaning

After cleaning the device, make sure that:

- cables, connectors and fittings are free of cleaning agents and
- cables, wires, connectors and electrical components are dry.

## 11.2 Maintenance

### Guidelines

Do not open the device! The device contains no parts to be maintained or repaired by the operator.

### Replacing the battery

#### **▲ WARNING**

#### **Injuries due to improper replacing of the battery!**

Improper replacing of the battery can lead to injuries as well as damage to the device.

- Switch off the device and disconnect it from the power supply before you start replacing the battery.
- Only use stipulated tools.
- Only use a replacement battery from SONOTEC.
- When replacing the battery, make sure that it is placed correctly in the housing.

1. Switch off the device and disconnect it from the power supply.
2. Remove the screw of the battery.  
🔑 Allen key: width 2 mm

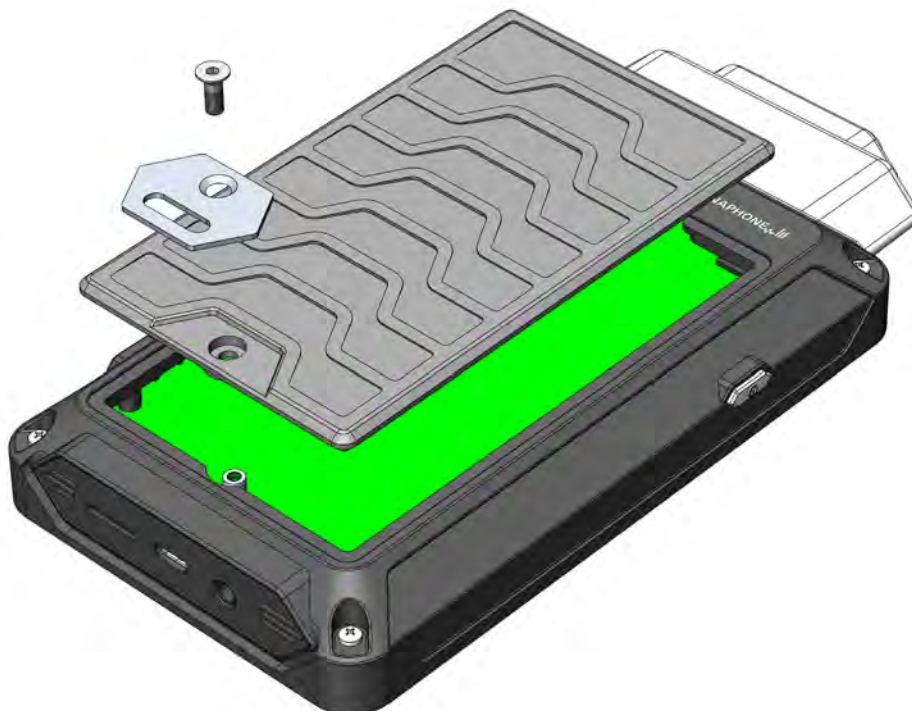

- Carefully remove the battery cover with the battery.

**ATTENTION** – Do not tear off the battery cables! Do not damage the battery!

- Disconnect the connector of the battery cable in the device.

**ACHTUNG** – Avoid touching components and/or the circuit board!



- Replace the battery
- Plug the connector of the replacement battery into the device until the connector clicks into place.
- Insert the replacement battery into the device.
- Screw in the screw of the battery and tighten it hand-tight.  
🔑 Allen key: width 2 mm

### Replacing the batteries of the headphones

For replacing the batteries, please refer to the manufacturer's operating manual.

## 12 Troubleshooting

Potential error	Possible cause	Troubleshooting
Software can no longer be operated		Switching the device off and on again (see „4.3 Switching the device on/off“ on page 25)
The app does not start up after installation	App installation has failed	Delete the app via the Software Manager and carry out installation again
The signals from the sensor are not displayed	Sensor detection is not working correctly	Disconnect the sensor from the device and then reconnect it. Switch the device off and on again to restart the sensor detection.
The headphones are not working	The headphones are not switched on	Switch on the headphones at the right-hand capsule
	The headphone batteries are discharged	Replace the batteries (2 × AAA) as described in the manufacturer's operating manual.
	Kopfhörer sind nicht korrekt angeschlossen	Check the connectors for correct fit.

If the error is not rectified by the solutions above, please contact our Service team.

Please have the following information to hand:

- Model ID and serial number of the device and sensors (located on the type labels)
- Version of the Measurement Core and installed app (located in the app overview in the “Software Manager”)

The following information may also be useful:

- Date of purchase and dealer name
- Active applications at the time of the error
- Log files of the SONAPHONE apps (located in the device directory **Internal Memory > Logs**)

## 13 Technical data

General data	
<b>Dimensions (W × H × D)</b>	90 × 174 × 25 mm (90 × 174 × 30 mm with high capacity battery)
<b>Weight</b>	370 g (420 g incl. high capacity battery)
<b>Materials</b>	Polycarbonate, ABS, chemically hardened glass
<b>Normen und Richtlinien</b>	EMV Richtlinie 2014/30/EU WEEE Richtlinie 2012/19/EU RoHS Richtlinie 2011/65/EU ASTM E1002-2005
Electrical data	
<b>Power supply</b>	Charger (5 V, 2.4 A)
<b>Battery</b>	Lithium-Polymer-battery (3.7 V, 4.05 Ah 7.75 Wh)
<b>Runtime</b>	8 ... 12 h (practical use) 4 h (continuous operation)
<b>Charging time</b>	4h (typically)
Connections and interfaces	
<b>Data export</b>	Slot for microSD card (up to 32 GB)
<b>Headphones</b>	Jack socket 3.5 mm
<b>Charger / Data exchange</b>	USB 2.0 Micro-B
<b>Ultrasonic sensors</b>	Socket LEMO 0B (4-pole)



Hardware	
<b>Processor</b>	ARM Cortex-A9 Dual Core 1.2 GHz
<b>RAM</b>	2 GB SDRAM
<b>Device storage</b>	System: 8 GB Flash Measurement data: 16 GB Flash
<b>Display</b>	Type: TFT, 5-point multi-touch Dimension: 5" Resolution: 800 × 480 Pixel
<b>Miscellaneous</b>	5-megapixel camera on the back of the device Integrated microphone Integrated speaker Integrated position sensor
Software	
<b>Operating system</b>	Android 4.4.2
<b>SONAPHONE Apps (factory pre-installed)</b>	LevelMeter Measurement Core Software Manager Hardware Manager SONAPHONE Setup
Ambient conditions	
<b>Operating temperature</b>	-10 °C ... +40 °C
<b>Storing temperature</b>	-20 °C ... +60 °C
<b>Charging temperature</b>	0 °C ... +20 °C
<b>Protection type</b>	IP40

## 14 Disposal

### 14.1 Recycling and taking back of used equipment

Electrical and electronic devices may pose a risk to health and the environment if disposed of incorrectly. They cannot therefore be disposed of as domestic waste according to WEEE Directive 2012/19/EU (Waste Electrical and Electronic Equipment Directive). Instead they must be taken to designated collecting points or returned to the manufacturer.

The following symbol indicates the legal duty to dispose of electronic devices as stipulated.



They must undergo specified recycling processes (e. g., with respect to batteries or circuit boards) which enable safe, environmentally compatible re-use or separate disposal of different device elements.

The return of used devices is regulated differently in different places. Find out from your local council about the return conditions for commercially used electronic devices.

The device, including rechargeable battery, contains no toxic substances requiring separate identification for disposal such as mercury (Hg), cadmium (Cd), lead (Pb) or chrome 6 (e. g., in plated parts or circuit boards).

## 14.2 Removing the battery

According to legal requirements, batteries must be disposed of separated from their electrical devices. For self-dependent disposal at designated collection points, the batteries must be removed from the device.

### ▲ WARNING

#### Injuries due to improper removing of the battery!

Improper removing of the battery can lead to injuries as well as damage to the device.

- Switch off the device and disconnect it from the power supply before you start removing the battery.
- Only use stipulated tools.

1. Switch off the device and disconnect it from the power supply.
2. Remove the screw of the battery.  
🔑 Allen key: width 2 mm

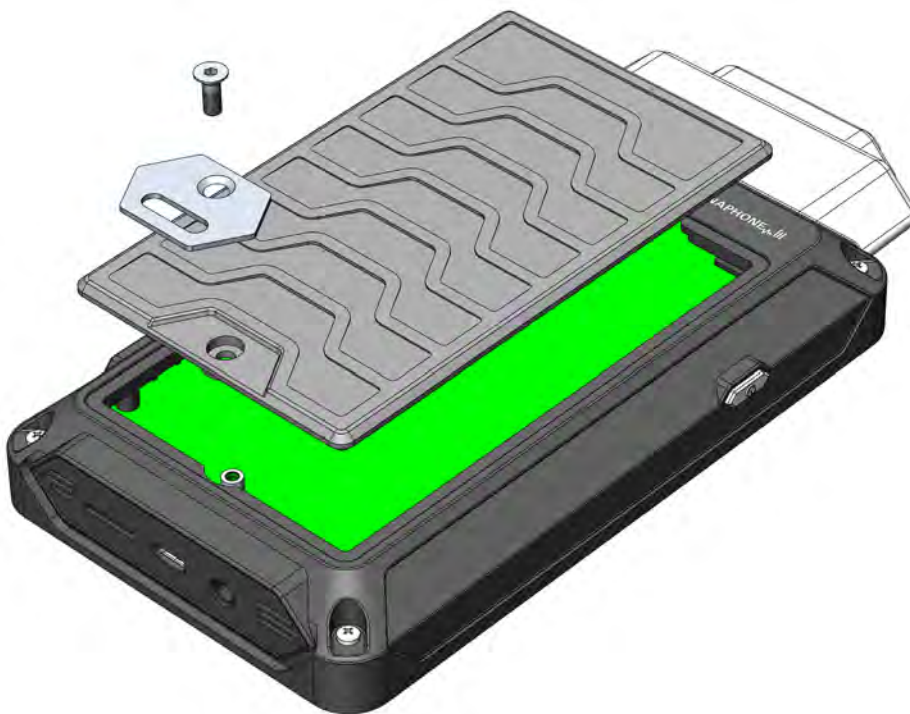

3. Carefully remove the battery cover with the battery.

**ATTENTION** – Do not tear off the battery cables! Do not damage the battery!

4. Disconnect the connector of the battery cable in the device.

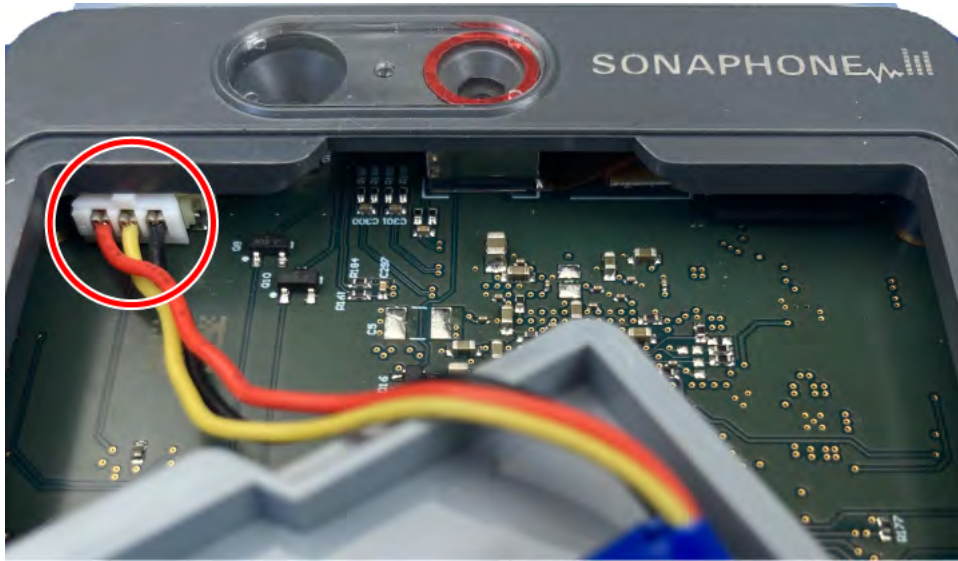

5. Dispose of the battery and the device separately according to the instructions.

## 15 Warranty

### Condition at delivery

All products and accessories have been tested thoroughly before they leave the factory, are state-of-the-art products at the time of delivery and adhere to all applicable safety regulations.

### Warranty

During the warranty period, SONOTEC GmbH will eliminate all deficiencies caused by material or manufacturing faults free of charge. SONOTEC GmbH will at its own discretion offer warranty by reparation or replacement of faulty products.

### Exceptions

Internal accumulators as well as damage caused by unintended use, by wear or by manipulation of the product are exempt from warranty. The warranty also does not cover those faults that affect value or usability of the product to a negligible amount.

### Responsibility of the user/operator

It lies within the responsibility of the users to ensure that the product has been installed and set-up properly and is used in a manner that does not impair safe operation.

### Operating errors

Operating errors can never be completely ruled out by the manufacturer. SONOTEC GmbH is in no way liable for any direct or indirect damage caused by operating errors (e.g. damage on software and/or hardware, damage by downtime, damage by malfunction as well as damage or loss of measurement and test data).

### Quality of captured data

The determination of valid test results, their interpretation and the actions derived therefrom are exclusively subject to the personal responsibility of the users. SONOTEC GmbH does not guarantee the correctness of determined test values and/or test results. SONOTEC GmbH does not assume liability for any faults or damages that might occur due to further use of determined test and measurement values.

## 16 Manufacturer information

### Copyright

© SONOTEC GmbH

All rights reserved.

All contents of this document are property of SONOTEC GmbH and are protected by copyright. Duplication, modification and/or distribution in any form, particularly for reprint, for photographic, mechanical or electronic reproduction or in the form of saving in data processing systems or data networks is forbidden without written approval by SONOTEC GmbH.

### Certifications and registrations

- Quality management according to ISO 9001:2015  
(Certificate Registration No.: 091006014)
- Registration according to ElektroG at the "stiftung elektro-altgeräte register" (ear):  
WEEE Reg. No. DE 22125904

### Contact

#### **Manufacturer**

SONOTEC GmbH  
Nauendorfer Str. 2  
06112 Halle (Saale), Germany

Phone: +49 345 13317-0  
mySONAPHONE@sonotec.de  
www.sonotec.eu

#### **USA**

SONOTEC US Inc.  
190 Blydenburgh Rd.  
Suite 8, 2nd Floor  
Islandia, New York 11749, USA

Phone: +1 631 4154758  
sales@sonotecusa.com  
www.sonotecusa.com